

Using iTunes Remote with Soundcast products

Soundcast transmitters can send the signal from any audio source (i.e. a computer, a stereo system, iPOD, CD player, mp3 player or any other sound device) to any of our receivers.

In this example a Universal Audio Transmitter (UAT) sends the audio from a Mac computer to an OutCast Outdoor Speaker



OutCast Outdoor Speaker

Universal
Audio
Transmitter
(UAT)

 **SOUNDCAST™**
UNLEASH YOUR AUDIO



While our products make this scenario possible, some users still have the need to have a visual reference of the music tracks that are being played by the Soundcast receiver they're using (OutCast, SpeakerCast, iCast receiver, Subcast receiver or OutCast Jr.).

For that reason we want to show a simple way to use the iTunes remote application in a Soundcast System setup.



Requirements for this setup are as follows:

- PC or Mac Computer with latest iTunes installed
- iTunes remote application installed *
- iPhone or iPod Touch with iTunes remote installed *
- UAT or iCast Transmitter from Soundcast Systems
- OutCast or any other wireless receiver from Soundcast Systems
- Your Music library!

* For instructions on how to install and/or troubleshoot iTunes remote application read the following documents from our website:

[How to control iTunes with your iPhone or iPod Touch](#)

[Troubleshooting iTunes remote](#)

iTunes Remote in a Soundcast System setup

Using
UAT

Setting up the system is pretty simple once you install the Remote application.

1. First restart your computer.
2. Connect your UAT and set both the UAT and the receiver to the same channel (in this example the OutCast).
3. Start iTunes
4. Start the Remote application on your iPod Touch or iPhone (it will look for your library and will load it).
5. Play your music right from your iPod Touch or iPhone.



OutCast
Outdoor Speaker



Universal Audio
Transmitter



iPhone or iPod
Touch with
iTunes Remote

You are now able to:

- Have access to your music from anywhere within your Wi-Fi network.
- Play back the music from your iTunes library through the OutCast outdoor speaker (or any Soundcast receiver) remotely.
- Locate songs, playlists, artists, albums of your computer's library and control all transport functions directly from your iPhone or iPod Touch wherever you are!
- Create new playlists on your iPhone or iPod Touch remotely.
- Control playback functions directly on the OutCast

Basic connection diagram

UAT sending audio from the computer to 1
OutCast outdoor speaker

Computer with iTunes
and iTunes Remote
applications installed

PC or Mac

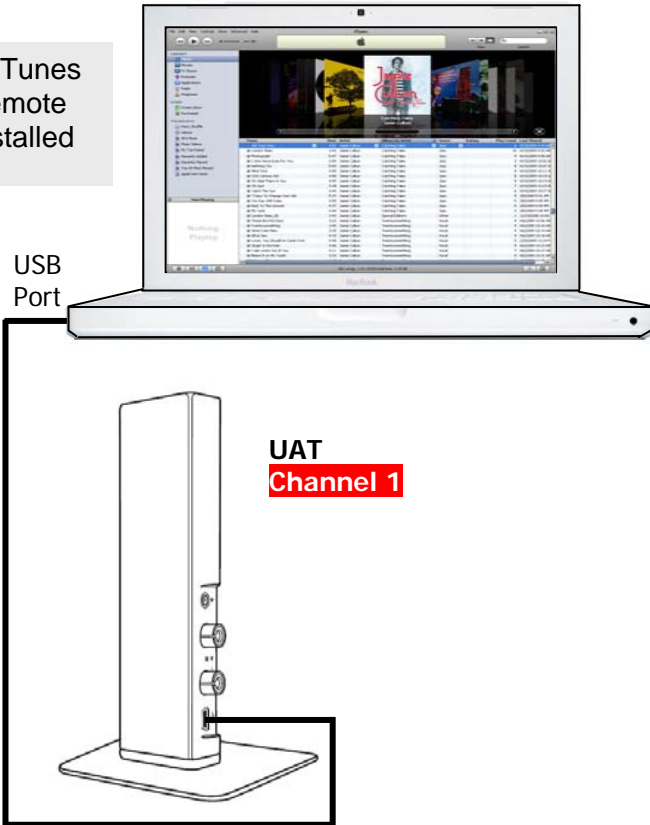

UAT set to
channel 1

iPhone or iPod
Touch with Remote
application installed



OutCast set
to channel 1

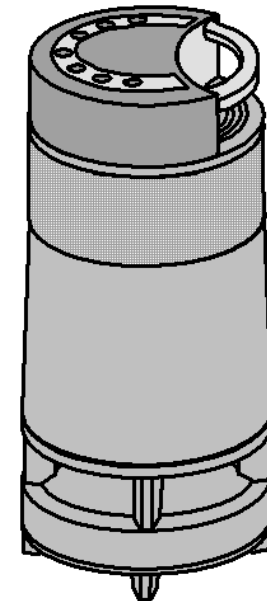

Advanced connection diagram

UAT sending audio to a pair of local speakers and to a pair of wireless OutCast outdoor speakers

Computer with iTunes and iTunes Remote applications installed



iPhone or iPod Touch with Remote application installed



OutCast 1
Channel 1

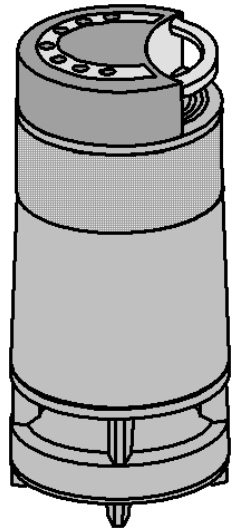

OutCast 2
Channel 1

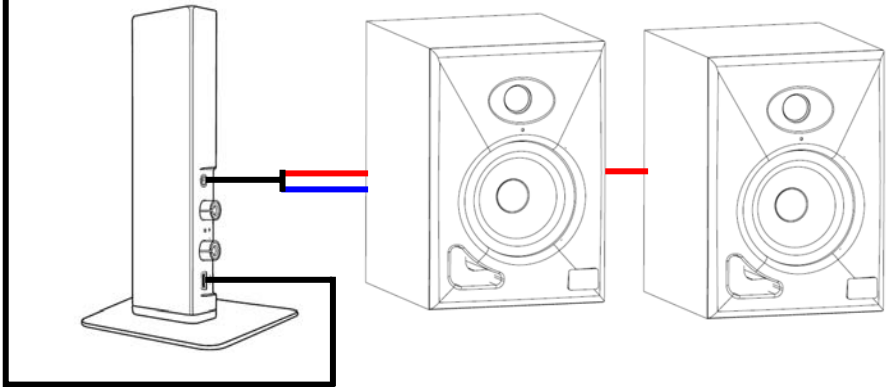
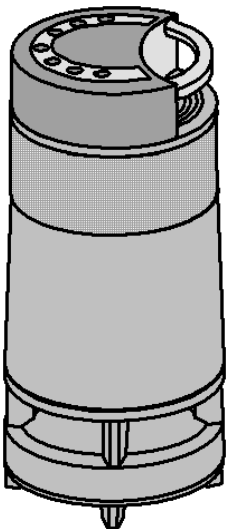

UAT
Set to Channel 1

Local speakers
(Powered Speakers shown)
If passive speakers are used,
an amplifier will be needed.

Troubleshooting the UAT

If after connecting your UAT you still hear the music coming from your computer speakers instead of your Soundcast system, it means your computer is set to play music from its internal soundcard.

To change this, follow the next steps:

MAC

With the UAT connected and iTunes playing...

1. Go to System Preferences
2. Under "Hardware" double click on the "Sound" icon.
3. A window will appear showing the sound devices your computer is actually seeing.
You should be able to see "USB Audio DAC" on the list of devices.
4. Select "USB Audio DAC" by clicking on it.

After performing these steps you will notice your Mac speakers will stop sounding and the music will start playing through your Soundcast System.

If you still don't hear any sound make sure your computer's volume slider is not all the way down (0 volume).



PC

With the UAT connected and iTunes playing...

1. Go to Control Panel
2. Click on the "Sound and Audio Devices" icon.
3. Under the Audio tab you will find "Sound and Playback".
Select "USB Audio DAC" as the default device.
4. Click on "Ok".

After performing these steps you will notice your PC speakers will stop sounding and the music will start playing through your Soundcast System.

If you still don't hear any sound make sure the slider on windows mixer is not all the way down (0 volume).



iTunes Remote in a Soundcast System setup

Using
iCast

Setting up the system is pretty simple once you install the Remote application.

1. Start iTunes.
2. Connect your iCast to the headphones output.
3. Set both the iCast Transmitter and the Receiver (in this example the OutCast) to the same channel.
4. Start the Remote application on your iPod Touch or iPhone (it will look for your library and will load it).
5. Play your music right from your iPOD Touch or iPhone.



iPhone or iPod
Touch with
iTunes Remote



iCast
Transmitter

You are now able to:

- Have access to your music from anywhere within your Wi-Fi network.
- Play back the music from your iTunes library through the OutCast outdoor speaker (or any Soundcast receiver) remotely.
- Locate songs, playlists, artists, albums of your computer's library and control all transport functions directly from your iPhone or iPod Touch wherever you are!
- Create new playlists on your iPhone or iPod Touch remotely.



OutCast
Outdoor
Speaker

Park

Basic connection diagram

Computer with iTunes and iTunes Remote applications installed

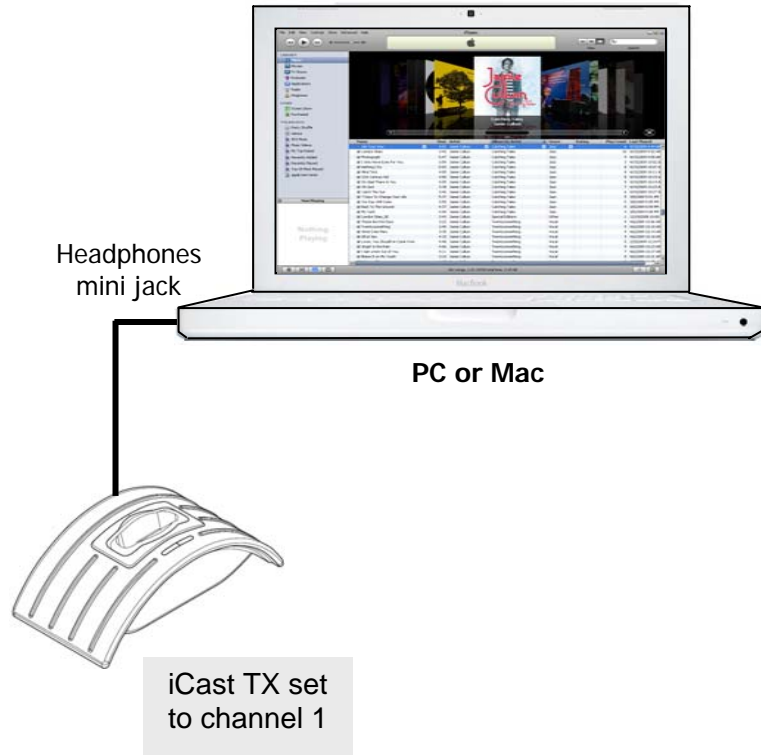

iCast TX sending audio from the computer to 1 OutCast outdoor speaker

iPhone or iPod Touch with Remote application installed



OutCast set to channel 1

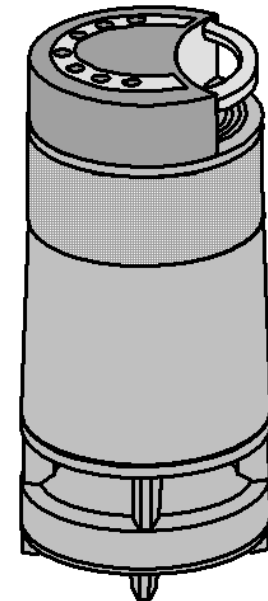

Advanced connection diagram

iCast TX sending audio to a pair of local speakers and to a pair of wireless OutCast outdoor speakers

